

Optix Series

LCD Monitor

Optix AG32CV (3KA0)

Optix AG32C (3KA0)

Contents

Copyright and Trademarks Notice	iii
Revision	iii
Technical Support	iii
Safety Instructions.....	iv
CE Conformity.....	vi
FCC-B Radio Frequency Interference Statement	vi
WEEE Statement	vii
Chemical Substances Information	vii
RoHS Statement	vii

Getting Started..... 1-1

Package Contents.....	1-2
Installing the Monitor Stand.....	1-3
Adjusting the Monitor	1-4
Monitor Overview	1-5
Connecting the Monitor to PC.....	1-7

OSD Setup 2-1

OSD Key	2-2
OSD Setup Menu	2-4

Appendix A-1

Specifications	A-2
Preset Display Modes	A-3
Troubleshooting	A-4

Copyright and Trademarks Notice

Copyright © Micro-Star Int'l Co., Ltd. All rights reserved. The MSI logo used is a registered trademark of Micro-Star Int'l Co., Ltd. All other marks and names mentioned may be trademarks of their respective owners. No warranty as to accuracy or completeness is expressed or implied. MSI reserves the right to make changes to this document without prior notice.

Revision

Revision	Date
V1.0	2019/12

Technical Support

If a problem arises with your product and no solution can be obtained from the user's manual, please contact your place of purchase or local distributor. Alternatively, please visit <https://www.msi.com/support/> for further guidance.

Safety Instructions



- ☑ Read the safety instructions carefully and thoroughly.
- ☑ All cautions and warnings on the device or user's manual should be noted.
- ☑ Refer servicing to qualified personnel only.



Keep the User's Guide that comes with the package for future reference.



To prevent fire or shock hazard, keep this device away from humidity and high temperature.



Lay this device on a reliable flat surface before setting it up.

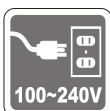

- ☑ Make sure that the power voltage is within its safety range and has been adjusted properly to the value of 100~240V before connecting the device to the power outlet. Do not disable the protective earth pin from the plug. The device must be connected to an earthed mains socket-outlet.
- ☑ Always disconnect the power cord or switch the wall socket off if the device would be left unused for a certain time to achieve zero energy consumption.

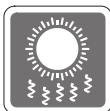

The ventilator on the device is used for air convection and to prevent the device from overheating. Do not cover the ventilator.



Do not leave the device in an unconditioned environment with a storage temperature above 60°C or below -20°C, which may damage the device.

NOTE: The maximum operating temperature is around 40°C.



When cleaning the device, be sure to remove the power plug. Use a piece of soft cloth rather than industrial chemical to clean the device. Never pour any liquid into the opening; that could damage the device or cause electric shock.



Place the power cord in a way that people are unlikely to step on it. Do not place anything on the power cord.



Always keep strong magnetic or electrical objects away from the device.



If any of the following situations arises, get the device checked by service personnel:

- ☐ The power cord or plug is damaged.
- ☐ Liquid has penetrated into the device.
- ☐ The device has been exposed to moisture.
- ☐ The device does not work well or you can not get it work according to user's manual.
- ☐ The device has dropped and damaged.
- ☐ The device has obvious sign of breakage.

Green Product Features

- ☐ Reduced energy consumption during use and stand-by
- ☐ Limited use of substances harmful to the environment and health
- ☐ Easily dismantled and recycled
- ☐ Reduced use of natural resources by encouraging recycling
- ☐ Extended product lifetime through easy upgrades
- ☐ Reduced solid waste production through take-back policy



Environmental Policy

- ☐ The product has been designed to enable proper reuse of parts and recycling and should not be thrown away at its end of life.
- ☐ Users should contact the local authorized point of collection for recycling and disposing of their end-of-life products.
- ☐ Visit the MSI website and locate a nearby distributor for further recycling information.
- ☐ Users may also reach us at gpcontdev@msi.com for information regarding proper disposal, take-back, recycling, and disassembly of MSI products.

★ Warning! Overuse of screens is likely to affect eyesight.

★ Recommendations:

1. Take a 10-minute break for every 30 minutes of screen time.
2. Children under 2 years of age should have no screen time. For children aged 2 years and over, screen time should be limited to less than one hour per day.

CE Conformity

This device complies with the requirements set out in the Council Directive on the Approximation of the Laws of the Member States relating to Electromagnetic Compatibility (2014/30/EU), Low-voltage Directive (2014/35/EU), ErP Directive (2009/125/EC) and RoHS directive (2011/65/EU).



This product has been tested and found to comply with the harmonized standards for Information Technology Equipment published under Directives of Official Journal of the European Union.

FCC-B Radio Frequency Interference Statement



This equipment has been tested and found to comply with the limits for a Class B digital device, pursuant to Part 15 of the FCC Rules. These limits are designed to provide reasonable protection against harmful interference in a residential installation. This equipment generates, uses and can radiate radio frequency energy and, if not installed and used in accordance with the instruction manual, may cause harmful interference to radio communications. However, there is no guarantee that interference will not occur in a particular installation. If this equipment does cause harmful interference to radio or television reception, which can be determined by turning the equipment off and on, the user is encouraged to try to correct the interference by one or more of the measures listed below:

- Reorient or relocate the receiving antenna.
- Increase the separation between the equipment and receiver.
- Connect the equipment into an outlet on a circuit different from that to which the receiver is connected.
- Consult the dealer or an experienced radio/television technician for help.

Notice 1

The changes or modifications not expressly approved by the party responsible for compliance could void the user's authority to operate the equipment.

Notice 2

Shielded interface cables and AC power cord, if any, must be used in order to comply with the emission limits.

This device complies with Part 15 of the FCC Rules. Operation is subject to the following two conditions:

1. this device may not cause harmful interference, and
2. this device must accept any interference received, including interference that may cause undesired operation.

MSI Computer Corp.
901 Canada Court, City of Industry, CA 91748, USA
(626)913-0828
www.msi.com

WEEE Statement

Under the European Union ("EU") Directive on Waste Electrical and Electronic Equipment, Directive 2002/96/EC, which takes effect on August 13, 2005, products of "electrical and electronic equipment" cannot be discarded as municipal waste anymore and manufacturers of covered electronic equipment will be obligated to take back such products at the end of their useful life.



Chemical Substances Information

In compliance with chemical substances regulations, such as the EU REACH Regulation (Regulation EC No. 1907/2006 of the European Parliament and the Council), MSI provides the information of chemical substances in products at:

https://www.msi.com/html/popup/csr/evmtprrt_pcm.html

RoHS Statement

Japan JIS C 0950 Material Declaration

A Japanese regulatory requirement, defined by specification JIS C 0950, mandates that manufacturers provide material declarations for certain categories of electronic products offered for sale after July 1, 2006.

https://www.msi.com/html/popup/csr/cemm_jp.html

https://tw.msi.com/html/popup/csr_tw/cemm_jp.html

India RoHS

This product complies with the "India E-waste (Management and Handling) Rule 2011" and prohibits use of lead, mercury, hexavalent chromium, polybrominated biphenyls or polybrominated diphenyl ethers in concentrations exceeding 0.1 weight % and 0.01 weight % for cadmium, except for the exemptions set in Schedule 2 of the Rule.

Turkey EEE Regulation

Conforms to the EEE Regulations of the Republic Of Turkey

Ukraine Restriction of Hazardous Substances

The equipment complies with requirements of the Technical Regulation, approved by the Resolution of Cabinet of Ministry of Ukraine as of December 3, 2008 № 1057, in terms of restrictions for the use of certain dangerous substances in electrical and electronic equipment.

Vietnam RoHS

As from December 1, 2012, all products manufactured by MSI comply with Circular 30/2011/TT-BCT temporarily regulating the permitted limits for a number of hazardous substances in electronic and electric products.

1

Getting Started

This chapter provides you with the information on hardware setup procedures. While connecting devices, be careful in holding the devices and use a grounded wrist strap to avoid static electricity.

IMPORTANT

- *The illustrations are for reference only. Your monitor may vary in appearance.*
- *Do not use any sharp objects on the monitor.*

Package Contents

1. Monitor
2. Stand
3. Stand Base with Screw
4. Power Cord
5. HDMI Cable (Optional)
6. DisplayPort Cable (Optional)
7. DVI-D Cable (Optional)
8. Quick Start Guide
9. Warranty Card

* Contact your place of purchase or local distributor if any of the items is damaged or missing.

* Package contents may vary by country.

Installing the Monitor Stand

1. Fit the stand to the monitor and tighten the stand with the screws.
2. Connect the base to the stand and tighten the base screw to secure the base.
3. Place the protection cover.

IMPORTANT

Place the monitor on a soft, protected surface to avoid scratching the display panel.

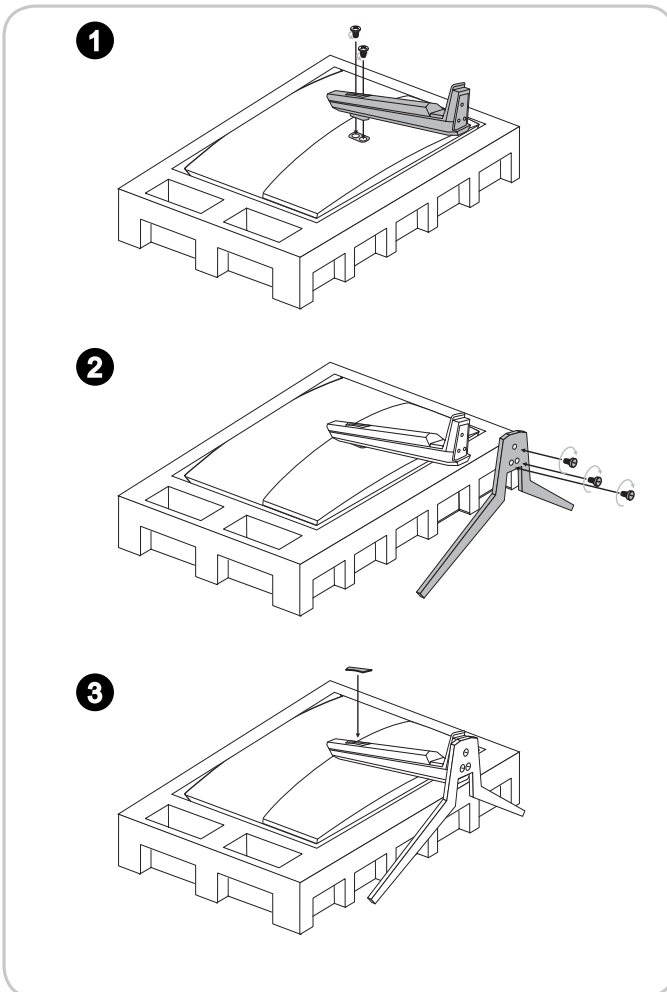

Adjusting the Monitor

This monitor is designed to maximize your viewing comfort with its adjustment capabilities.

IMPORTANT

Avoid touching the display panel when adjusting the monitor.

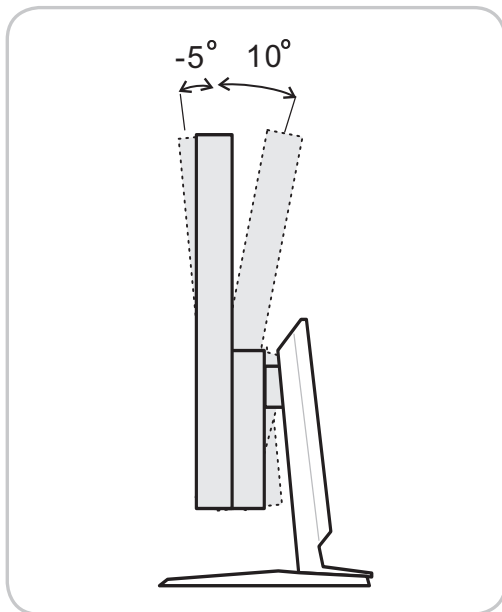

Monitor Overview

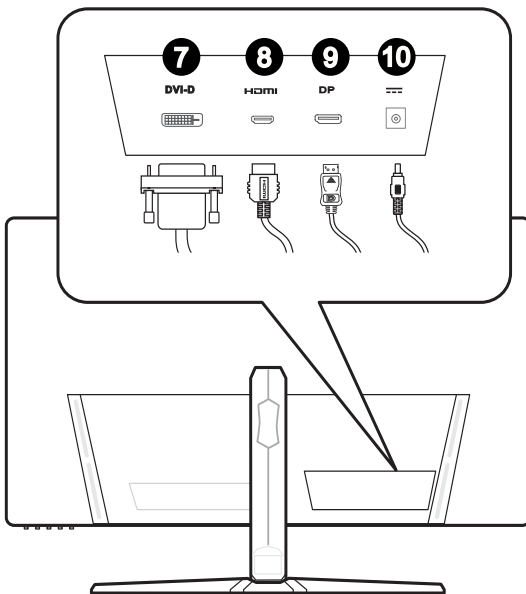
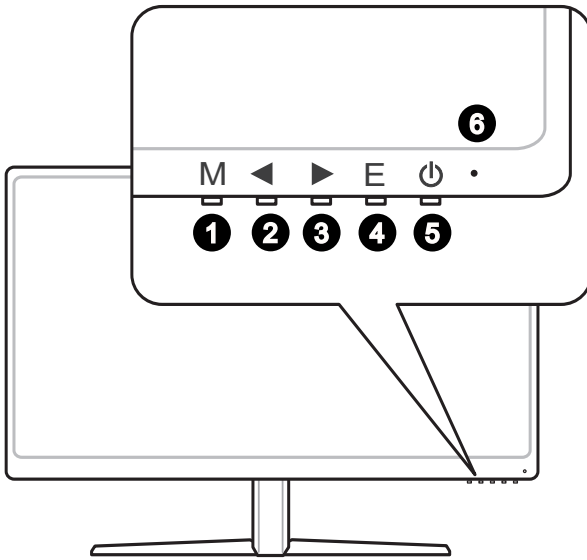

1 Menu Key

2 Select Key

3 Select Key

4 Enter Key

5 Power Button

6 LED Indicator:
Blue: On
Blinking Blue: Standby

7 DVI-D Port

8 HDMI Port 

9 DisplayPort

10 Power Jack

Connecting the Monitor to PC

1. Turn off your computer.
2. Connect the DVI-D/HDMI/DisplayPort cable from the monitor to your computer.
3. Assemble the monitor power adapter & power cord.(Figure A)
4. Connect the power cord to the monitor power jack. (Figure B)
5. Plug the power cord into the electrical outlet. (Figure C)
6. Turn on the monitor. (Figure D)
7. Power on the computer then monitor will auto detect signal source.

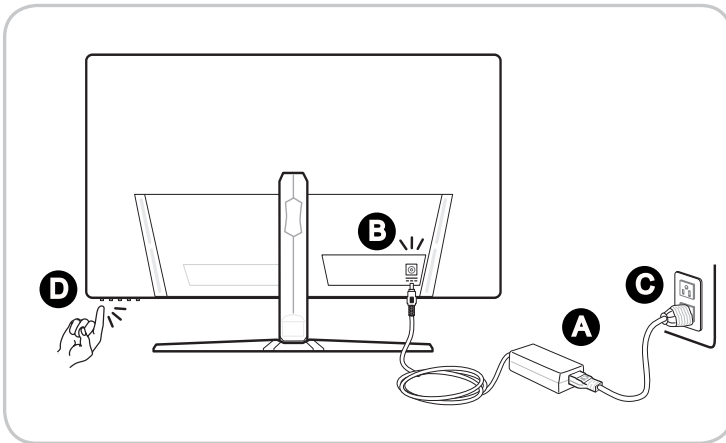

2

OSD Setup

This chapter provides you with essential information on OSD Setup.

IMPORTANT







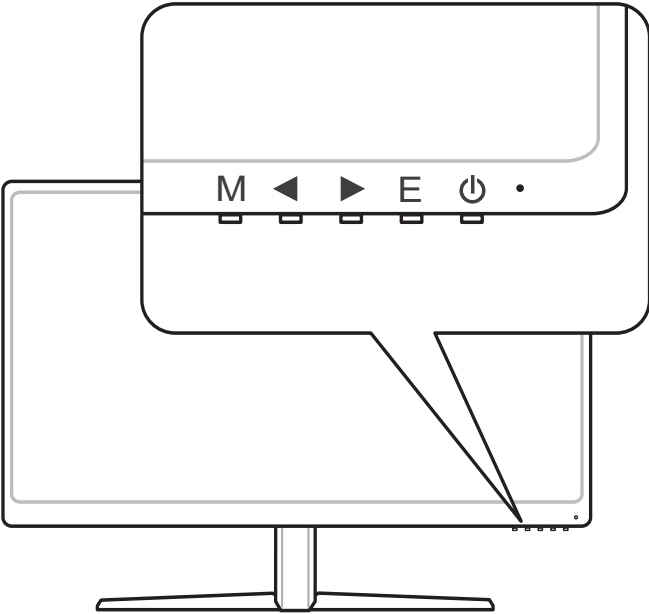



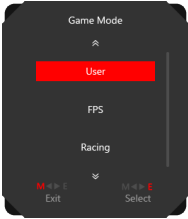



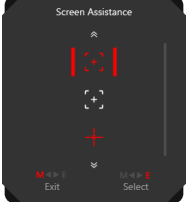

All information is subject to change without prior notice.

OSD Key

The monitor comes with a set of OSD Key that helps to control the On-Screen Display (OSD) menu.



Without entering OSD menu, you can use these OSD keys as hot keys for quick settings.

OSD Key	Function	Basic Operations
	Game Mode 	<ul style="list-style-type: none"> ■ Press  button to enter this setting. ■ Press  or  button to select. ■ Press  button to confirm and exit.
	Screen Assistance 	<ul style="list-style-type: none"> ■ Press  button to enter this setting. ■ Press  or  button to select. ■ Press  button to confirm and exit.
	Input Source 	<ul style="list-style-type: none"> ■ Press  button to enter this setting. ■ Press  or  button to select. ■ Press  button to confirm and exit.

OSD Setup Menu

Press **M** button to launch the On-Screen Display (OSD) main menu. In OSD screen, use **M** **◀ ▶** **E** buttons to tune the desired function to suit your personal preferences.

These OSD keys operations are as follows.

OSD Key	Basic Operations
M	<ul style="list-style-type: none">▪ Exiting the current menu
◀	<ul style="list-style-type: none">▪ Selecting function menus and items▪ Allowing upward adjustment in function values
▶	<ul style="list-style-type: none">▪ Selecting function menus and items▪ Allowing downward adjustment in function values
E	<ul style="list-style-type: none">▪ Entering the submenus▪ Confirming a selection or setting



➤ GAMING

1st Level Menu	2nd/3rd Level Menu		Description
Game Mode	User		User mode.
	FPS		First person shooting game mode.
	Racing		Racing game mode.
	RTS		Strategic game mode.
	RPG		RPG game mode.
Night Vision	OFF		<ul style="list-style-type: none"> This function optimizes background brightness and is recommended for FPS games.
	Normal		
	Strong		
	Strongest		
	A.I.		
Response Time	Normal		<ul style="list-style-type: none"> Users can adjust Response Time in any Mode.
	Fast		
	Fastest		
Zero Latency	<input type="checkbox"/> (OFF)		<ul style="list-style-type: none"> Users can adjust this item in any mode , any input source , any resolution and any screen refresh rate. While FreeSync is enabled, Zero Latency have to set to ON.
	<input checked="" type="checkbox"/> (ON)		
Refresh Rate	Location	Left Top	<ul style="list-style-type: none"> Users can adjust Refresh Rate in any Mode. Default Refresh Rate Location is Left Top. Location is adjustable in OSD Menu.
		Right Top	
		Left Bottom	
		Right Bottom	
		Customize	
	OFF		
	ON		

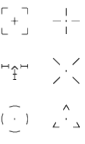
1st Level Menu	2nd/3rd Level Menu	Description	
Alarm Clock	Location	Left Top	<ul style="list-style-type: none"> Users can adjust Alarm Clock in any Mode. Default Alarm Clock Location is Left Top. Users can select their own location.
		Right Top	
		Left Bottom	
		Right Bottom	
		Customize	
	OFF		
	15:00	00:01~99:59	
30:00			
45:00			
60:00			
Screen Assistance	None	 <ul style="list-style-type: none"> Users can adjust Screen Assistance in any Mode. 	
	Icon		
	Position		
	Reset		
FreeSync	<input type="checkbox"/> (OFF)	<ul style="list-style-type: none"> FreeSync prevents screen tearing. DisplayPort or HDMI default is ON and can be adjusted ON/OFF in any mode, any resolution, any input source and any screen refresh rate. 	
	<input checked="" type="checkbox"/> (ON)		

► Professional

1st Level Menu	2nd Level Menu	Description
Pro Mode	User	Default mode. All items can be adjusted by users.
	Reader	All items can be adjusted by users.
	Cinema	All items can be adjusted by users.
	Designer	All items can be adjusted by users.
Eye Saver	<input type="checkbox"/> (OFF)	<ul style="list-style-type: none"> Eye Saver protects your eyes against blue light. When enabled, Eye Saver adjusts the screen color temperature to a more yellow glow. Users can adjust Eye Saver in any Mode. When Pro Mode is set to Reader, it is mandatory to enable Eye Saver.
	<input checked="" type="checkbox"/> (ON)	
HDCR	<input type="checkbox"/> (OFF)	<ul style="list-style-type: none"> Users can adjust HDCR in any Mode. HDCR enhances image quality by increasing the contrast of images. When HDCR is set to ON, Brightness will be grayed out.
	<input checked="" type="checkbox"/> (ON)	
Image Enhancement	OFF	<ul style="list-style-type: none"> Image Enhancement enhances image edges to improve their acutance. Users can adjust Image Enhancement in any Mode.
	Weak	
	Medium	
	Strong	
	Strongest	

► Image

1st Level Menu	2nd/3rd Level Menu	Description		
Brightness	0-100	<ul style="list-style-type: none"> Users can adjust Brightness in User, RTS, RPG and Reader mode. 		
Contrast	0-100	<ul style="list-style-type: none"> Users can adjust Contrast in any Mode. 		
Sharpness	0-5	<ul style="list-style-type: none"> Users can adjust Sharpness in any Mode. Sharpness improves clarity and details of images. 		
Color Temperature	Cool	<ul style="list-style-type: none"> Color Temperature default is Normal. Users can adjust Color Temperature in Customization mode. 		
	Normal			
	Warm			
	Customization		<table border="1"> <tr> <td>R (0-100)</td> </tr> <tr> <td>G (0-100)</td> </tr> <tr> <td>B (0-100)</td> </tr> </table>	R (0-100)
R (0-100)				
G (0-100)				
B (0-100)				
Screen Size	Auto	<ul style="list-style-type: none"> Users can adjust Screen Size in any mode, any resolution and any screen refresh rate. 		
	4:3			
	16:9			

► Input Source

1st Level Menu	2nd/3rd Level Menu	Description
DVI		Users can adjust Input Source in any Mode.
HDMI		
DP		

► Hot Key

1st Level Menu	2nd Level Menu	Description
Left / Right / Enter	OFF	<ul style="list-style-type: none"> Left Button default is Game Mode. Right Button default is Screen Assistance. Enter Button default is Input Source.
	Brightness	
	Game Mode	
	Screen Assistance	
	Alarm Clock	
	Input Source	
	Refresh Rate	
	Information on Screen	

► Setting



1st Level Menu	2nd Level Menu	Description
Language	繁體中文	<ul style="list-style-type: none"> ■ Language factory default is English. ■ Users have to press the Middle Button to confirm and apply the Language setting. ■ Language is an independent setting. Users' own language setting will override the factory default. When users set Reset to Yes, Language will not be changed.
	English	
	Français	
	Deutsch	
	Italiano	
	Español	
	한국어	
	日本語	
	Русский	
	Português	
	简体中文	
	ไทย	
	Bahasa Indonesia	
	हिन्दी	
Türkçe		
(More languages coming soon)		
Transparency	0~5	Users can adjust Transparency in any Mode.
OSD Time Out	5~30	Users can adjust OSD Time Out in any Mode.
LED	<input type="checkbox"/> (OFF)	<ul style="list-style-type: none"> ■ Users can adjust LED to ON or OFF. ■ Default is ON. ■ Optix AG32C supported.
	<input checked="" type="checkbox"/> (ON)	
Power Button	OFF	<ul style="list-style-type: none"> ■ When pressing the power button over 5 seconds, the monitor will be turned off. ■ Users can set the power status when the monitor is off . ■ Set to OFF, the monitor will be turned off totally. ■ Set to Standby, only panel and backlight are off, but the monitor still can be activated by OS detection, avoiding desk-top icon and screen be refreshed.
	Standby	
Information on Screen	<input type="checkbox"/> (OFF)	<ul style="list-style-type: none"> ■ The information of the monitor status will be showed on the right side of the screen. ■ Users can enable or disable the Information on Screen. Default is OFF.
	<input checked="" type="checkbox"/> (ON)	
Reset	YES	Users can Reset and restore settings to original OSD Default in any Mode.
	NO	

A

Appendix

IMPORTANT

All information is subject to change without prior notice.

Specifications

Model	Optix AG32CV (3KA0) / Optix AG32C (3KA0)	
Size	31.5 inch	
Curvature	1800R	
Panel Type	VA	
Resolution	1920 x 1080@165Hz	
Aspect Ratio	16:9	
Brightness (nits)	250	
Contrast Ratio	3000:1	
Refresh Rate	165Hz	
Response Time	1ms	
Input Interface	DVI-D x 1, HDMI 2.0 x1, DP x1	
View Angles	178°(H) , 178°(V)	
DCI-P3/ sRGB	85% / 115%	
Surface Treatment	Anti-glare	
Display Colors	16.7M (8 bit)	
Power Type	External Power Adapter	
Adapter Spec.	Model: SOY-1200500 / SUN-1200500	
Power Input	100~240Vac, 50~60Hz, Max. 1.7A	
Power Output	12V, 5A	
Adjustment (Tilt)	-5° ~ 10°	
VESA Mounting	<ul style="list-style-type: none"> ■ Plate Type: 100 x 100 mm ■ Screw Type: M4x10 mm <ul style="list-style-type: none"> ▶ Thread Diameter: 4 mm ▶ Thread Pitch: 0.7 mm ▶ Thread Length: 10 mm 	
Dimension (W x H x D)	710.38 x 509.55 x 212.5 mm	
Net Weight	6.62 kg (net) / 8.94 kg (gross)	
Environment	Operating	Temperature: 0°C to 40°C Humidity: 20% to 90%, non-condensing Altitude: 0 ~ 5000m
	Storage	Temperature: -20°C to 60°C Humidity: 10% to 90%, non-condensing

Preset Display Modes

Standard	Resolution	Optix AG32CV (3KA0) / Optix AG32C (3KA0)	
		HDMI / DP	DVI-D
VGA	640x480 @60Hz	V	V
	640x480 @67Hz	V	V
	640x480 @72Hz	V	V
	640x480 @75Hz	V	V
Dos-Mode	720x400@70Hz	V	V
	720x480@60Hz	V	
	720x576@50Hz	V	
SVGA	800x600 @56Hz	V	V
	800x600 @60Hz	V	V
	800x600 @72Hz	V	V
	800x600 @75Hz	V	V
		V	V
XGA	1024x768 @60Hz	V	V
	1024x768 @70Hz	V	V
	1024x768 @75Hz	V	V
SXGA	1280x1024 @60Hz	V	V
	1280x1024 @75Hz	V	V
WXGA+	1440x900 @60Hz	V	V
WSXGA+	1680x1050 @60Hz	V	V
Full HD	1920x1080 @60Hz	V	V
	1920x1080 @120Hz	V	V
	1920x1080 @144Hz	V	V
	1920x1080 @165Hz	V	V
Video Timing Resolution	480P	V	V
	576P	V	V
	720P	V	V
	1080i	V	V
	1080P	V	V
	1080P @120Hz	V	V

Troubleshooting

The power LED is off.

- Press the monitor power button again.
- Check if the monitor power cable is properly connected.

No image.

- Check if the computer graphics card is properly installed.
- Check if the computer and monitor are connected to electrical outlets and are turned on.
- Check if the monitor signal cable is properly connected.
- The computer may be in Standby mode. Press any key to activate the monitor.

The screen image is not properly sized or centered.

Refer to Preset Display Modes to set the computer to a setting suitable for the monitor to display.

No Plug & Play.

- Check if the monitor power cable is properly connected.
- Check if the monitor signal cable is properly connected.
- Check if the computer and graphics card are Plug & Play compatible.

The icons, font or screen are fuzzy, blurry or have color problems.

- Avoid using any video extension cables.
- Adjust brightness and contrast.
- Adjust RGB color or tune color temperature.
- Check if the monitor signal cable is properly connected.
- Check for bent pins on the signal cable connector.

The monitor starts flickering or shows waves.

- Change the refresh rate to match the capabilities of your monitor.
- Update your graphics card drivers.
- Keep the monitor away from electrical devices that may cause electromagnetic interference (EMI).